

FREEDOM[®] CENTERPIECE

User Manual

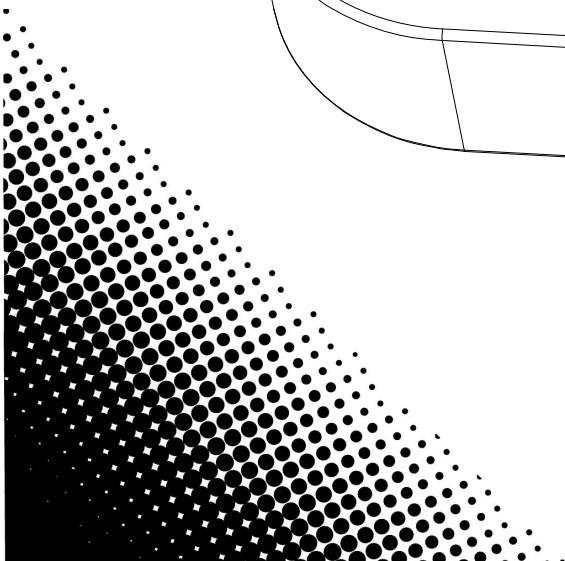
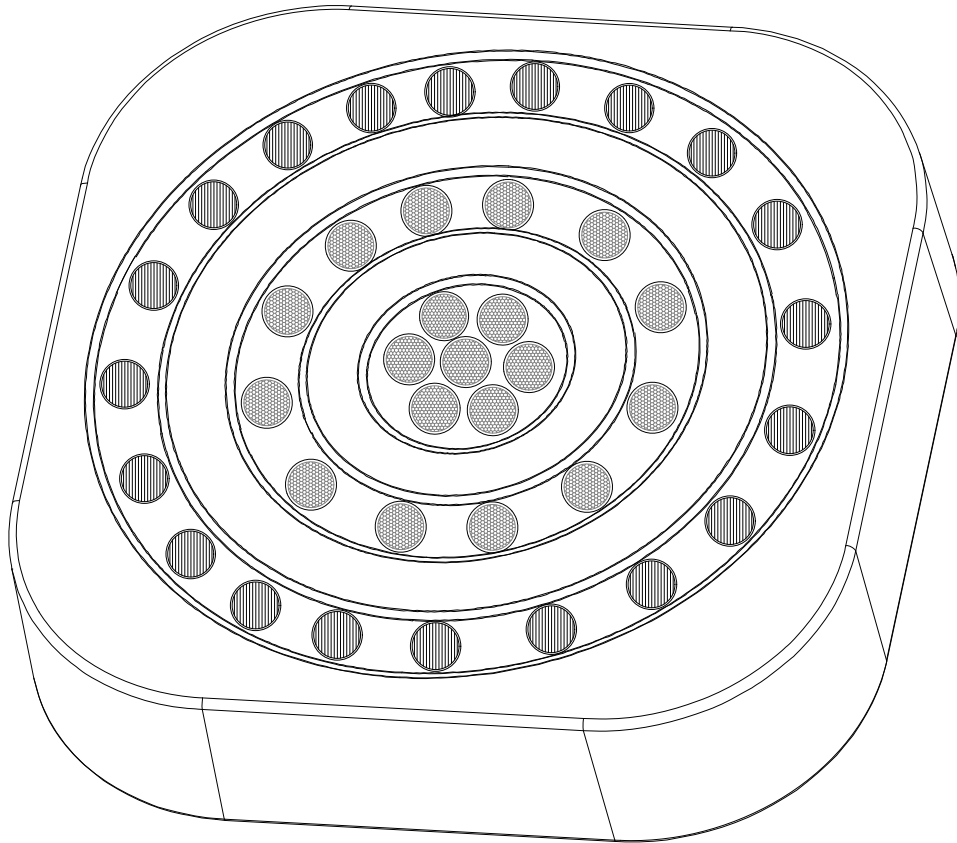

CHAUVET 

TABLE OF CONTENTS

1. Before You Begin	1
What Is Included	1
Unpacking Instructions	1
Claims	1
Text Conventions	1
Symbols	1
Disclaimer	1
Intellectual Property	1
Safety Notes.....	2
2. Introduction	3
Product Overview.....	3
Product Dimensions.....	4
3. Setup	5
AC Power.....	5
Battery Power.....	5
Charging the Battery	5
Battery Life Indicator	5
4. Operation	6
Control Panel Operation.....	6
Menu Map	6
DMX Linking.....	8
DMX Personality and Starting Address.....	8
DMX Values	8
Zones for DMX Control.....	8
DMX Channel Assignments and Values	9
16-Channel.....	9
12-Channel (2)	11
12-Channel (1)	12
8-Channel.....	13
Configuration (Standalone).....	13
Automatic Programs and Speed	13
Sound-Active Mode	13
Preset Color Mode	13
Custom Color Mixing.....	14
IRC-6 Infrared Remote Control	14
IRC-6 Operation	14
5. Maintenance	15
Product Maintenance	15
6. Technical Specifications	16
7. Returns	17
8. Contact Us	18

1. Before You Begin

What Is Included

- 4x Freedom Centerpiece
- 4x Black Housing Covers
- Multi-Charger
- Power Cord
- IRC-6 Remote
- Carrying Bag
- Quick Reference Guide

Unpacking Instructions

Carefully unpack the product immediately and check the container to make sure all the parts are in the package and are in good condition.

Claims





If the box or the contents (the product and included accessories) appear damaged from shipping, or show signs of mishandling, notify the carrier immediately, not Chauvet. Failure to report damage to the carrier immediately may invalidate your claim. In addition, keep the box and contents for inspection.

For other issues, such as missing components or parts, damage not related to shipping, or concealed damage, file a claim with Chauvet within 7 days of delivery.

Text Conventions

Convention	Meaning
1–512	A range of values
50/60	A set of values of which only one can be chosen
Settings	A menu option not to be modified
Menu > Settings	A sequence of menu options to be followed
<ENTER>	A button to be pressed on the product's control panel
ON	A value to be entered or selected

Symbols

Symbol	Meaning
	Electrical warning. Not following these instructions may cause electrical damage to the product, accessories, or the user.
	Critical installation, configuration, or operation information. Not following these instructions may make the product not work, cause damage to the product, or cause harm to the operator.
	Important installation or configuration information. The product may not function correctly if this information is not used.
	Useful information.

Disclaimer

Chauvet believes that the information contained in this manual is accurate in all respects. However, Chauvet assumes no responsibility and specifically disclaims any and all liability to any party for any loss, damage or disruption caused by any errors or omissions in this document, whether such errors or omissions result from negligence, accident or any other cause. Chauvet reserves the right to revise the content of this document without any obligation to notify any person or company of such revision, however, Chauvet has no obligation to make, and does not commit to make, any such revisions. Download the latest version from www.chauvetdj.com.

Intellectual Property

The works of authorship contained in this manual, including, but not limited to, all design, text and images are owned by Chauvet.

© Copyright 2019 Chauvet & Sons, LLC. All rights reserved.

Electronically published by Chauvet in the United States of America.

CHAUVET, the Chauvet logo, and Freedom Centerpiece are registered trademarks or trademarks of Chauvet & Sons LLC (d/b/a Chauvet and Chauvet Lighting) in the United States and other countries. Other company and product names and logos referred to herein may be trademarks of their respective companies.

Safety Notes



- Always connect the product to a grounded circuit to avoid the risk of electrocution.
 - Always disconnect the product from the power source before cleaning or replacing the fuse.
 - Avoid direct eye exposure to the light source while the product is on.
 - Make sure the power cord is not crimped or damaged.
 - Never disconnect the product from power by pulling or tugging on the cord.
 - Make sure there are no flammable materials close to the product when operating.
 - Do not touch the product's housing when operating because it may be very hot.
 - Do not charge the battery of the product in a closed case or container.

 - The product is not intended for permanent installation.
 - The voltage of the outlet to which you are connecting this product must be within the range stated on the decal or rear panel of the product.
 - This product is for indoor or temporary outdoor use (IP54). Do not expose to harsh or excessively corrosive environmental conditions (whether indoors or outdoors), including, but not limited to, extreme temperatures, humidity, atmospheric conditions (including salinity or pressure), radiation (UV, infrared or nuclear), shock and conditions which exceed the product's Ingress Protection (IP) rating.
- 
- Never connect the product to a dimmer or rheostat.
 - Make sure to replace the fuse with another of the same type and rating.
 - Never carry the product from the power cord or any moving part. Always use the hanging/mounting bracket.
 - The maximum ambient temperature is 104 °F (40 °C). Do not operate this product at higher temperatures.
 - In the event of a serious operating problem, stop using the product immediately.
 - Never attempt to repair the product. Repairs carried out by unskilled people can lead to damage or malfunction. Please contact the nearest authorized technical assistance center.
 - To eliminate unnecessary wear and improve its lifespan, during periods of non-use completely disconnect the product from power via breaker or by unplugging it.



Keep this User Manual for future use. If the product is sold to someone else, be sure that they also receive this document.

2. Introduction

Product Overview

Back Panel View

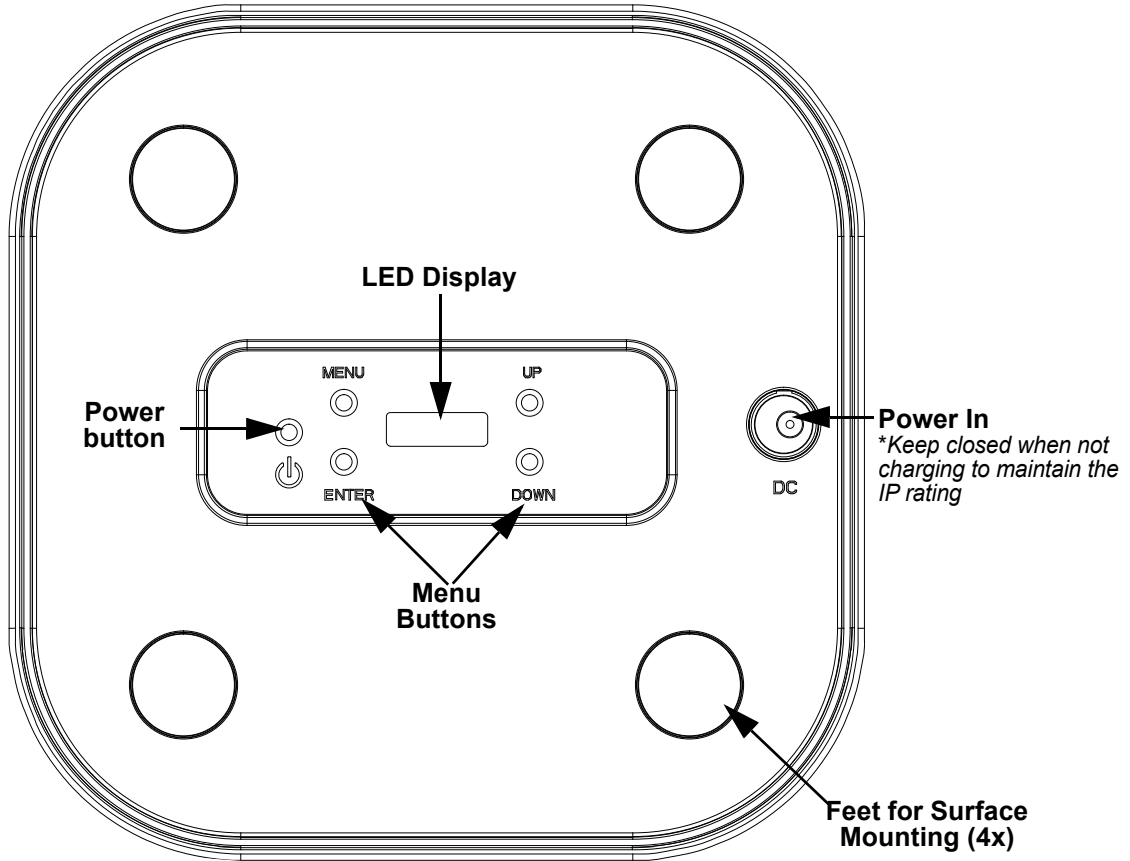

Product Dimensions

Front View

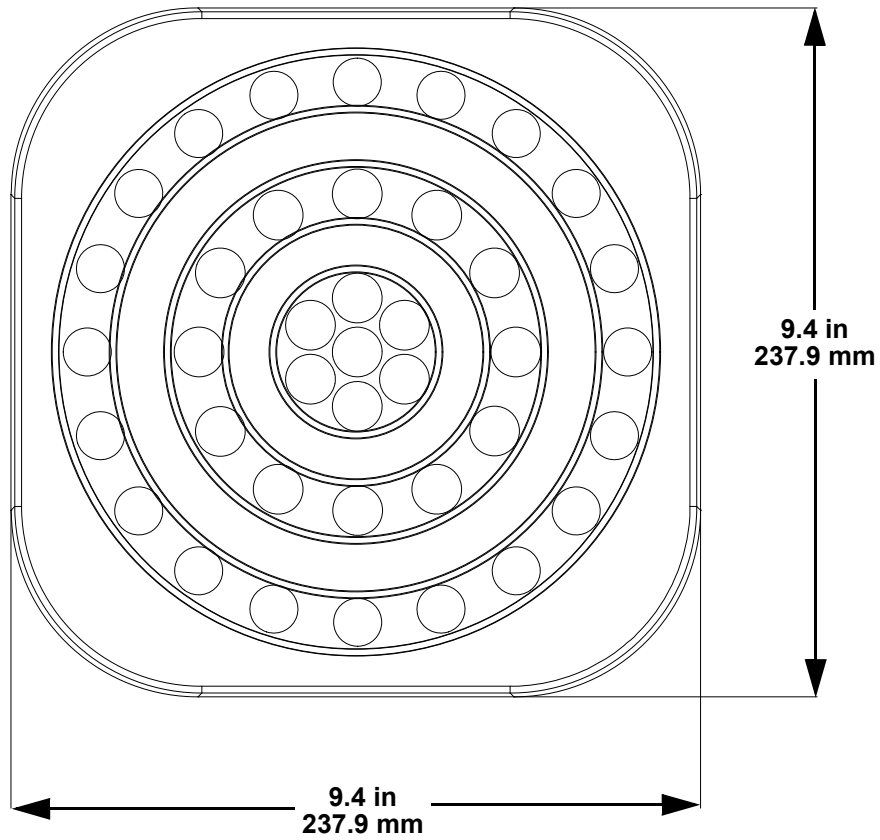

Side View

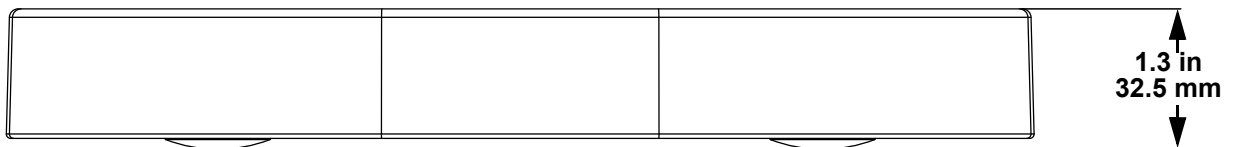

3. Setup

AC Power

The Freedom Centerpiece has an auto-ranging power supply and it can work with an input voltage range of 100 to 240 VAC, 50/60 Hz.

To determine the product's power requirements (circuit breaker, power outlet, and wiring), use the current value listed on the label affixed to the product's back panel, or refer to the product's specifications chart.

The listed current rating indicates the product's average current draw under normal conditions.



- **Always connect the product to a protected circuit (a circuit breaker or fuse). Make sure the product has an appropriate electrical ground to avoid the risk of electrocution or fire.**
- **To eliminate unnecessary wear and improve its lifespan, during periods of non-use completely disconnect the product from power via breaker or by unplugging it.**



Never connect the product to a rheostat (variable resistor) or dimmer circuit, even if the rheostat or dimmer channel serves only as a 0 to 100% switch.

Battery Power

The Freedom Centerpiece comes with a rechargeable lithium battery for cable free operation.

Charging the Battery

The battery charges whenever the Freedom Centerpiece is plugged into the external multi-charger and the charger is plugged into a power source. If the product is plugged in and not in operation, make sure the product is turned off.



- **When using the multi-charger, the Freedom Centerpiece must be powered OFF. The units will NOT charge if powered on.**
- **The LED indicator light will flash if you overpower your units.**



Do not close the lid of the case while Freedom Centerpiece batteries are charging.

Battery Life Indicator

The indicators on the LED Menu Display show how much battery life remains available. The drawing below provides a key to reading the battery life indicators.

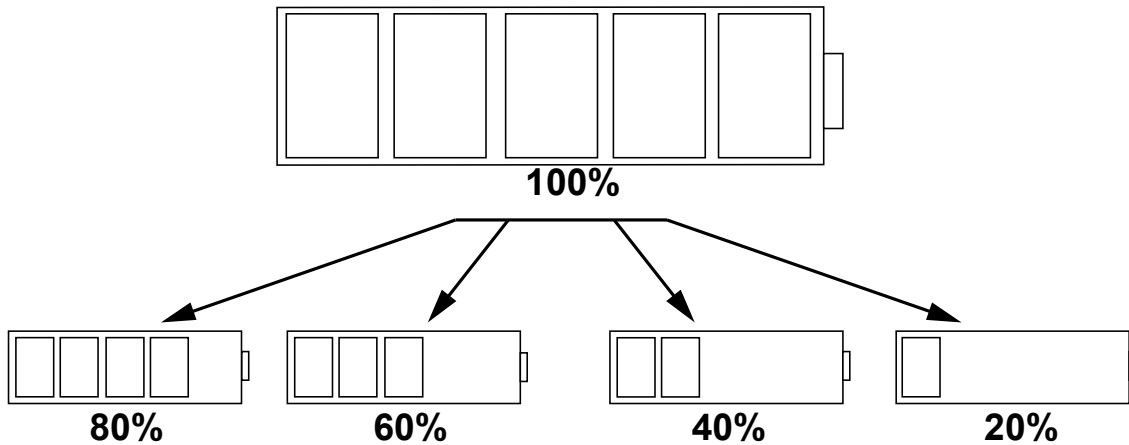

Battery Run Time

Maximum Run Time (all colors on)	Recharge Time
Up to 8 hours	6.5 hours

4. Operation

Control Panel Operation

To access the control panel functions, use the four buttons located underneath the display. Please refer to the [Product Overview](#) to see the button locations on the control panel.

Button	Function
<MENU>	Press to find an operation mode or to back out of the current menu option
<UP>	Press to scroll up the list of options or to increase the numeric value in a function
<DOWN>	Press to scroll down the list of options or to decrease the numeric value in a function
<ENTER>	Press to activate a menu option or set the selected value in a function

Menu Map

Mode	Programming Levels		Description	
DMX Address	001–505		Sets DMX starting address	
DMX Channel	8Ch		Sets DMX personality	
	12Ch1			
	12Ch2			
	16Ch			
Static	Fixed Color	Ring1	R	Red
			G	Green
			B	Blue
			W	White
			GB	Green + Blue
			RB	Red + Blue
			RG	Red + Green
			RGB	Red + Green + Blue
			RW	Red + White
			GW	Green + White
			BW	Blue + White
			RGW	Red + Green + White
		RBW	Red + Blue + White	
		GBW	Green + Blue + White	
		RGBW	Red + Green + Blue + White	
		Ring2	R	Red
			G	Green
			B	Blue
			W	White
			GB	Green + Blue
			RB	Red + Blue
			RG	Red + Green
			RGB	Red + Green + Blue
			RW	Red + White
GW	Green + White			
BW	Blue + White			
RGW	Red + Green + White			
RBW	Red + Blue + White			
GBW	Green + Blue + White			
RGBW	Red + Green + Blue + White			

Mode	Programming Levels				Description
Static (cont'd)	Fixed Color (cont'd)	Ring3	CW		Cool White
			WW		Warm White
			CW+WW		Cool White + Warm White
	Manual Color	Ring1	R	0–255	Adjust the levels of red, green, blue, and white to create custom colors for Ring 1
			G	0–255	
			B	0–255	
			W	0–255	
		Ring2	R	0–255	Adjust the levels of red, green, blue, and white to create custom colors for Ring 2
			G	0–255	
			B	0–255	
			W	0–255	
		Ring3	CW	0–255	Adjust the levels of cool white and warm white to create custom colors for Ring 3
WW			0–255		
Auto Show	Auto 1–15		Speed 1–100		Sets automatic programs and automatic speed
Sound Show	Sound Sense		000–100		Sets sound-active program
Wireless Setting	Wireless On/Off		On		Turns wireless capability on or off
			Off		
	Wireless Mode		Transmit		Set to transmitter or receiver channel
			Receive		
Wireless Channel		CH01–CH16		Select the wireless channel	
IR Setting	On				Turns infrared on or off
	Off				
White Balance	Off				Turn off the white balance
	Manual	R	125–255		Select red, green, blue, and white to set the white balance
		G			
		B			
		W			
Dimmer Mode	Off				No dimming effect
	Dimmer 1				Sets the dimming speed, fast to slow
	Dimmer 2				
	Dimmer 3				
Back Light	10S				Turns off after 10 seconds
	30S				Turns off after 30 seconds
	2Mins				Turns off after 2 minutes
	On				Does not turn off
Information	Fixture Hours		9999H		Displays the total operating hours of the device
	Version		V0.2		Shows installed software version
Factory Reset	No				Resets to factory settings
	Yes				

DMX Linking

The Freedom Centerpiece does not have a DMX input or output, but can be controlled using a D-Fi Hub or FlareCON Air products.

DMX Personality and Starting Address

When selecting a starting DMX address, always consider the number of DMX channels the selected DMX mode uses. If the starting address is set too high, access to some of the product's channels could be restricted.

To ensure full access to all channels available in each DMX mode, the highest recommended DMX address is **497**.

For information about the DMX protocol, download the DMX Primer from www.chauvetdj.com.

To select the starting address, do the following:

1. Press **<MENU>** repeatedly until **DMX Channel** shows on the display.
2. Press **<ENTER>**.
3. Use **<UP>** or **<DOWN>** to select **8Ch**, **12Ch1**, **12Ch2**, or **16Ch**.
4. Press **<ENTER>**.
5. Press **<MENU>** repeatedly until **DMX Address** shows on the display.
6. Press **<ENTER>** and **001** will show on the display.
7. Use **<UP>** or **<DOWN>** to select the starting address.
8. Press **<ENTER>**.

DMX Values

Zones for DMX Control

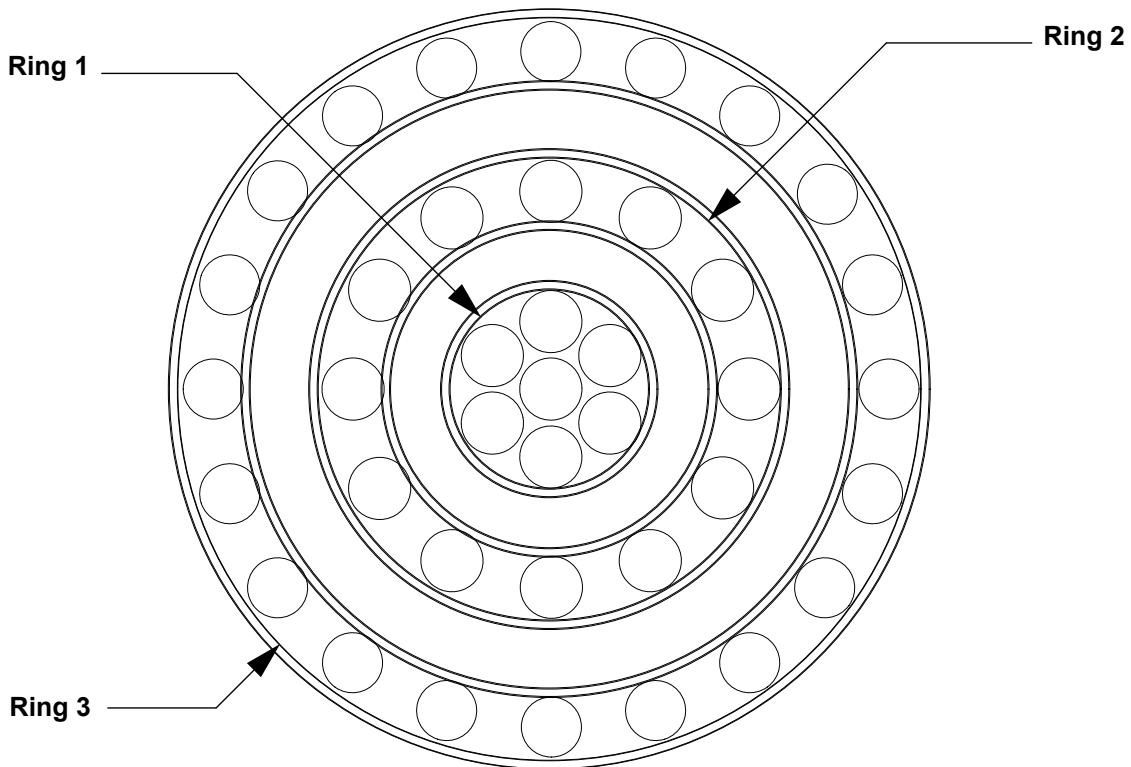

DMX Channel Assignments and Values

16-Channel

Channel	Function	Value	Percent/Setting
1	Dimmer	000 ⇔ 255	0–100%
2	Red, Ring 1	000 ⇔ 255	0–100%
3	Green, Ring 1	000 ⇔ 255	0–100%
4	Blue, Ring 1	000 ⇔ 255	0–100%
5	White, Ring 1	000 ⇔ 255	0–100%
6	Red, Ring 2	000 ⇔ 255	0–100%
7	Green, Ring 2	000 ⇔ 255	0–100%
8	Blue, Ring 2	000 ⇔ 255	0–100%
9	White, Ring 2	000 ⇔ 255	0–100%
10	Warm White, Ring 3	000 ⇔ 255	0–100%
11	Cool White, Ring 3	000 ⇔ 255	0–100%
12	Strobe	000 ⇔ 010	No function
		011 ⇔ 255	Strobe, slow to fast
13	Color Macro	000 ⇔ 010	No function
		011 ⇔ 030	R: 100% G: 0–100% B: 0%
		031 ⇔ 050	R: 100–0% G: 100% B: 0%
		051 ⇔ 070	R: 0% G: 100% B: 0–100%
		071 ⇔ 090	R: 0% G: 100–0% B: 100%
		091 ⇔ 110	R: 0–100% G: 0% B: 100%
		111 ⇔ 130	R: 100% G: 0% B: 100–0%
		131 ⇔ 150	R: 100% G: 0–100% B: 0–100%
		151 ⇔ 170	R: 100–0% G: 100–0% B: 100%
		171 ⇔ 200	R: 100% G: 100% B: 100% W: 100%
		201 ⇔ 205	Color 1
		206 ⇔ 210	Color 2
		211 ⇔ 215	Color 3
		216 ⇔ 220	Color 4
		221 ⇔ 225	Color 5
		226 ⇔ 230	Color 6
		231 ⇔ 235	Color 7
236 ⇔ 240	Color 8		
241 ⇔ 245	Color 9		
246 ⇔ 250	Color 10		
251 ⇔ 255	Color 11		

Channel	Function	Value	Percent/Setting
14	Auto/Sound-Active Programs	000 ⇔ 010	No function
		011 ⇔ 026	Auto program 1
		027 ⇔ 042	Auto program 2
		043 ⇔ 058	Auto program 3
		059 ⇔ 074	Auto program 4
		075 ⇔ 089	Auto program 5
		090 ⇔ 104	Auto program 6
		105 ⇔ 120	Auto program 7
		121 ⇔ 135	Auto program 8
		136 ⇔ 150	Auto program 9
		151 ⇔ 165	Auto program 10
		166 ⇔ 180	Auto program 11
		181 ⇔ 195	Auto program 12
		196 ⇔ 210	Auto program 13
		211 ⇔ 225	Auto program 14
226 ⇔ 240	Auto program 15		
241 ⇔ 255	Sound-active Program		
15	Auto Speed	000 ⇔ 255	Auto program speed, slow to fast
	Sound Sensitivity	000 ⇔ 010	Sound-sensitivity off
		011 ⇔ 255	Sound sensitivity, low to high
16	Dimmer Speed Mode	000 ⇔ 051	Preset dimmer speed from display menu
		052 ⇔ 101	Dimmer speed mode off
		102 ⇔ 152	Dimmer speed mode 1 (fast)
		153 ⇔ 203	Dimmer speed mode 2 (medium)
		204 ⇔ 255	Dimmer speed mode 3 (slow)

12-Channel (2)

Channel	Function	Value	Percent/Setting
1	Dimmer	000 ⇔ 255	0–100%
2	Red	000 ⇔ 255	0–100%
3	Green	000 ⇔ 255	0–100%
4	Blue	000 ⇔ 255	0–100%
5	White	000 ⇔ 255	0–100%
6	Warm White	000 ⇔ 255	0–100%
7	Cool White	000 ⇔ 255	0–100%
8	Strobe	000 ⇔ 010	No function
		011 ⇔ 255	Strobe, slow to fast
9	Color Macro	000 ⇔ 010	No function
		011 ⇔ 030	R: 100% G: 0–100% B: 0%
		031 ⇔ 050	R: 100–0% G: 100% B: 0%
		051 ⇔ 070	R: 0% G: 100% B: 0–100%
		071 ⇔ 090	R: 0% G: 100–0% B: 100%
		091 ⇔ 110	R: 0–100% G: 0% B: 100%
		111 ⇔ 130	R: 100% G: 0% B: 100–0%
		131 ⇔ 150	R: 100% G: 0–100% B: 0–100%
		151 ⇔ 170	R: 100–0% G: 100–0% B: 100%
		171 ⇔ 200	R: 100% G: 100% B: 100% W: 100%
		201 ⇔ 205	Color 1
		206 ⇔ 210	Color 2
		211 ⇔ 215	Color 3
		216 ⇔ 220	Color 4
		221 ⇔ 225	Color 5
		226 ⇔ 230	Color 6
		231 ⇔ 235	Color 7
		236 ⇔ 240	Color 8
241 ⇔ 245	Color 9		
246 ⇔ 250	Color 10		
251 ⇔ 255	Color 11		

Channel	Function	Value	Percent/Setting
10	Auto/Sound-Active Programs	000 ⇔ 010	No function
		011 ⇔ 026	Auto program 1
		027 ⇔ 042	Auto program 2
		043 ⇔ 058	Auto program 3
		059 ⇔ 074	Auto program 4
		075 ⇔ 089	Auto program 5
		090 ⇔ 104	Auto program 6
		105 ⇔ 120	Auto program 7
		121 ⇔ 135	Auto program 8
		136 ⇔ 150	Auto program 9
		151 ⇔ 165	Auto program 10
		166 ⇔ 180	Auto program 11
		181 ⇔ 195	Auto program 12
		196 ⇔ 210	Auto program 13
		211 ⇔ 225	Auto program 14
226 ⇔ 240	Auto program 15		
241 ⇔ 255	Sound-active program		
11	Auto Speed	000 ⇔ 255	Auto program speed, slow to fast
	Sound Sensitivity	000 ⇔ 010	Sound-sensitivity off
		011 ⇔ 255	Sound sensitivity, low to high
12	Dimmer Speed Mode	000 ⇔ 051	Preset dimmer speed from display menu
		052 ⇔ 101	Dimmer speed mode off
		102 ⇔ 152	Dimmer speed mode 1 (fast)
		153 ⇔ 203	Dimmer speed mode 2 (medium)
		204 ⇔ 255	Dimmer speed mode 3 (slow)

12-Channel (1)

Channel	Function	Value	Percent/Setting
1	Dimmer	000 ⇔ 255	0–100%
2	Red, Ring 1	000 ⇔ 255	0–100%
3	Green, Ring 1	000 ⇔ 255	0–100%
4	Blue, Ring 1	000 ⇔ 255	0–100%
5	White, Ring 1	000 ⇔ 255	0–100%
6	Red, Ring 2	000 ⇔ 255	0–100%
7	Green, Ring 2	000 ⇔ 255	0–100%
8	Blue, Ring 2	000 ⇔ 255	0–100%
9	White, Ring 2	000 ⇔ 255	0–100%
10	Warm White, Ring 3	000 ⇔ 255	0–100%
11	Cool White, Ring 3	000 ⇔ 255	0–100%
12	Strobe	000 ⇔ 010	No function
		011 ⇔ 255	Strobe, slow to fast

Operation

8-Channel

Channel	Function	Value	Percent/Setting
1	Dimmer	000 ⇄ 255	0–100%
2	Red	000 ⇄ 255	0–100%
3	Green	000 ⇄ 255	0–100%
4	Blue	000 ⇄ 255	0–100%
5	White	000 ⇄ 255	0–100%
6	Warm White	000 ⇄ 255	0–100%
7	Cool White	000 ⇄ 255	0–100%
8	Strobe	000 ⇄ 010	No function
		011 ⇄ 255	Strobe, slow to fast

Configuration (Standalone)

Set the product in one of the standalone modes to control without a DMX controller..



Never connect a product that is operating in any standalone mode to a DMX string connected to a DMX controller. Products in standalone mode may transmit DMX signals that could interfere with the DMX signals from the controller.

Automatic Programs and Speed

To run the Freedom Centerpiece in Automatic mode, follow the instructions below:

1. Press **<MENU>** repeatedly until **Auto Show** displays on the menu.
2. Press **<ENTER>**.
3. Use **<UP>** or **<DOWN>** to select from **Auto 1–15**.
4. Press **<ENTER>**.
5. Use **<UP>** or **<DOWN>** to increase or decrease the speed (**Speed 1–100**).
6. Press **<ENTER>**.

Sound-Active Mode

To run the Freedom Centerpiece in sound-active mode, do the following:

1. Press **<MENU>** repeatedly until **Sound Show** displays on the menu.
2. Press **<ENTER>**.
3. Use **<UP>** or **<DOWN>** to increase or decrease the sound sensitivity (**Sound Sense 000–100**).
4. Press **<ENTER>**.

Preset Color Mode

To run the Freedom Centerpiece on a preset static color, do the following:

1. Press **<MENU>** repeatedly until **Static** shows on the display.
2. Press **<ENTER>**.
3. Use **<UP>** or **<DOWN>** until **Fixed Color** displays on the menu.
4. Press **<ENTER>**.
5. Use **<UP>** or **<DOWN>** to select **Ring 1–3**.
6. Press **<ENTER>**.
7. Use **<UP>** or **<DOWN>** to the desired static color for each ring.



Ring 1 and Ring 2 can display any combination of red, green, blue, and white. Ring 3 can only display cool white and warm white.

Custom Color Mixing

To mix a custom static color on the Freedom Centerpiece, do the following:

1. Press **<MENU>** repeatedly until **Static** shows on the display.
2. Press **<ENTER>**.
3. Use **<UP>** or **<DOWN>** until **Manual Color** displays on the menu.
4. Press **<ENTER>**.
5. Use **<UP>** or **<DOWN>** to select **Ring 1–3**.
6. Press **<ENTER>** to cycle through the following options:
 - **R** (red)
 - **G** (green)
 - **B** (blue)
 - **W** (white)
 - **CW** (cool white)
 - **WW** (warm white)
7. Press **<ENTER>** to select an option.
8. Use **<UP>** or **<DOWN>** to increase or decrease the selected value, from **0–255** (for **Ring 1 & 2**: red, green, blue, or white; for **Ring 3**: cool white or warm white).
9. Repeat steps 6–8 for each ring until the colors are set as desired.

IRC-6 Infrared Remote Control

The Freedom Centerpiece is compatible with the IRC-6 infrared remote control from Chauvet.

IRC-6 Operation

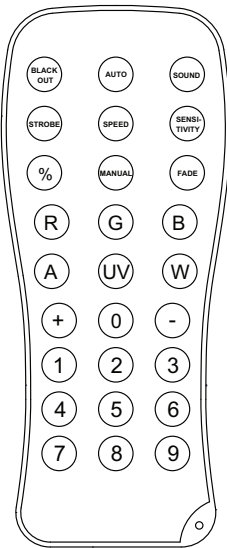

Automatic Mode

Automatic mode will enable you to run the automatic programs on the product.

To turn on Automatic mode (snap) with the IRC-6:

1. Press **<AUTO>** on the IRC-6.
2. Press **<+>** or **<->** to choose between the different auto programs.

To adjust the speed of the automatic program:

1. Press **<SPEED>** on the IRC-6.
2. Press **<+>** or **<->** to increase or decrease the speed of the program.

Sound-Active Mode

To turn on Sound-Active mode with the IRC-6:

1. Press **<SOUND>** on the IRC-6.
2. Press **<+>** or **<->** to select a sound-active program.

To adjust the sound sensitivity:

1. Press **<SENSITIVITY>** on the IRC-6.
2. Press **<+>** or **<->** to increase or decrease the sensitivity.

Manual Color Control

To select a preset static color with the IRC-6:

1. Press **<MANUAL>** on the IRC-6.
2. Press any number between 0–9 to choose your color.

To manually control the RGBW percentage with the IRC-6:

1. Press **<MANUAL>** on the IRC-6.
2. Select the color to be edited, from **<R>** (red), **<G>** (green), **** (blue), **<W>** (white), **<A>** (warm white), or **<UV>** (cool white).
3. Press **<+>** or **<->** to increase or decrease the intensity of the selected color.
4. Repeat steps 2 and 3 until the product outputs as desired.

Strobe

To adjust the strobe rate with the IRC-6:

1. Press **<STROBE>** on the IRC-6.
2. Press **<+>** or **<->** to increase or decrease the strobe rate.
3. Set to **0** to turn off the strobe.

Black Out

To black out the lights with the IRC-6:

1. Press **<BLACK OUT>** on the IRC-6.

This will turn off all the lights until the button is pressed again.

5. Maintenance

Product Maintenance

Dust build-up reduces light output performance and can cause overheating. This can lead to reduction of the light source's life and/or mechanical wear. To maintain optimum performance and minimize wear, clean your lighting products at least twice a month. However, be aware that usage and environmental conditions could be contributing factors to increase the cleaning frequency.

To clean the product, follow the instructions below:

1. Unplug the product from power.
2. Wait until the product is at room temperature.
3. Use a vacuum (or dry compressed air) and a soft brush to remove dust collected on the external surface/vents.
4. Clean all transparent surfaces with a mild soap solution, ammonia-free glass cleaner, or isopropyl alcohol.
5. Apply the solution directly to a soft, lint free cotton cloth or a lens cleaning tissue.
6. Softly drag any dirt or grime to the outside of the transparent surface.
7. Gently polish the transparent surfaces until they are free of haze and lint.



Always dry the transparent surfaces carefully after cleaning them.

6. Technical Specifications

Dimensions and Weight

Length	Width	Height	Weight
9.4 in (237.9 mm)	9.4 in (237.9 mm)	1.3 in (32.5 mm)	3 lb (1.3 kg)

Note: Dimensions in inches rounded to the nearest decimal digit.

Power

Power Supply Type	Range	Voltage Selection
Switching (internal)	100 to 240 VAC, 50/60 Hz	Auto-ranging

Parameter	120 V, 60 Hz	230 V, 50 Hz
Consumption	23 W	22 W
Operating Current	337 mA	185 mA
Fuse	1.6 A, 250 V	1.6 A, 250 V

Power I/O	U.S./Worldwide	UK/Europe
Power input connector	IEC	IEC
Power Cord plug	Edison (U.S.)	Local Plug

Light Source

Source	Type	Color	Quantity	Power	Current	Lifespan
Ring 1	LED	RGBW	7	0.2 W	0.018 mA	50,000 hours
Ring 2	LED	RGBW	12	0.2 W	0.018 mA	50,000 hours
Ring 3	LED	CW/WW	20	0.1 W	0.018 mA	50,000 hours

Photometrics

Strobe Rate	Beam Angle	Field Angle
0 to 24 Hz	23°	36°

Thermal

Maximum External Temperature	Cooling System
104 °F (40 °C)	Convection

DMX

Channel Range	Optional Controllers
8, 12, or 16	IRC-6

Ordering

Product Name	Item Code	UPC Number
Freedom Centerpiece	03031575	781462219239

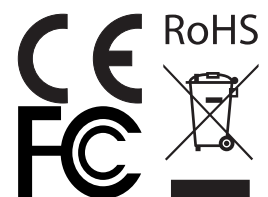

Returns

In case you need to get support or return a product:

- If you are located in the US, contact Chauvet World Headquarters.
- If you are located in the UK or Ireland, contact Chauvet Europe Ltd.
- If you are located in Benelux, contact Chauvet Europe BVBA.
- If you are located in France, contact Chauvet France.
- If you are located in Germany, contact Chauvet Germany.
- If you are located in Mexico, contact Chauvet Mexico.
- If you are located in any other country, DO NOT contact Chauvet. Instead, contact your local distributor. See www.chauvetdj.com for distributors outside the US, UK, Ireland, Benelux, France, Germany, or Mexico.



If you are located outside the US, UK, Ireland, Benelux, France, Germany, or Mexico, contact your distributor of record and follow their instructions on how to return Chauvet products to them. Visit our website www.chauvetdj.com for contact details.

Call the corresponding Chauvet Technical Support office and request a Return Merchandise Authorization (RMA) number before shipping the product. Be prepared to provide the model number, serial number, and a brief description of the cause for the return.

To submit a service request online, go to www.chauvetdj.com/service-request.

Send the merchandise prepaid, in its original box, and with its original packing and accessories. Chauvet will not issue call tags.

Clearly label the package with the RMA number. Chauvet will refuse any product returned without an RMA number.



Write the RMA number on a properly affixed label. DO NOT write the RMA number directly on the box.

Before sending the product, clearly write the following information on a piece of paper and place it inside the box:

- Your name
- Your address
- Your phone number
- RMA number
- A brief description of the problem

Be sure to pack the product properly. Any shipping damage resulting from inadequate packaging will be your responsibility. FedEx packing or double-boxing are recommended.



Chauvet reserves the right to use its own discretion to repair or replace returned product(s).

Contact Us

General Information	Technical Support
Chauvet World Headquarters	
Address: 5200 NW 108th Ave. Sunrise, FL 33351 Voice: (954) 577-4455 Fax: (954) 929-5560 Toll Free: (800) 762-1084	Voice: (844) 393-7575 Fax: (954) 756-8015 Email: chauvetcs@chauvetlighting.com Website: www.chauvetdj.com
Chauvet Europe Ltd	
Address: Unit 1C Brookhill Road Industrial Estate Pinxton, Nottingham, UK NG16 6NT Voice: +44 (0) 1773 511115 Fax: +44 (0) 1773 511110	Email: UKtech@chauvetlighting.eu Website: www.chauvetdj.eu
Chauvet Europe BVBA	
Address: Stokstraat 18 9770 Kruishoutem Belgium Voice: +32 9 388 93 97	Email: BNLtech@chauvetlighting.eu Website: www.chauvetdj.eu
Chauvet France	
Address: 3, Rue Ampère 91380 Chilly-Mazarin France Voice: +33 1 78 85 33 59	Email: FRtech@chauvetlighting.fr Website: www.chauvetdj.eu
Chauvet Germany	
Address: Bruno-Bürgel-Str. 11 28759 Bremen Germany Voice: +49 421 62 60 20	Email: DEtech@chauvetlighting.de Website: www.chauvetdj.eu
Chauvet Mexico	
Address: Av. de las Partidas 34 - 3B (Entrance by Calle 2) Zona Industrial Lerma Lerma, Edo. de México, CP 52000 Voice: +52 (728) 690-2010	Email: servicio@chauvet.com.mx Website: www.chauvetdj.mx

Visit the applicable website above to verify our contact information and instructions to request support. Outside the US, United Kingdom, Ireland, Mexico, France, Germany, or Benelux, contact the dealer of record.