

# FREEDOM

## H1

### User Manual

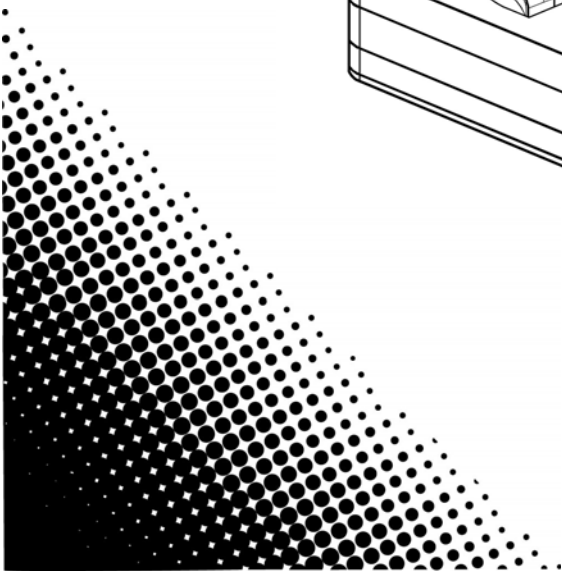
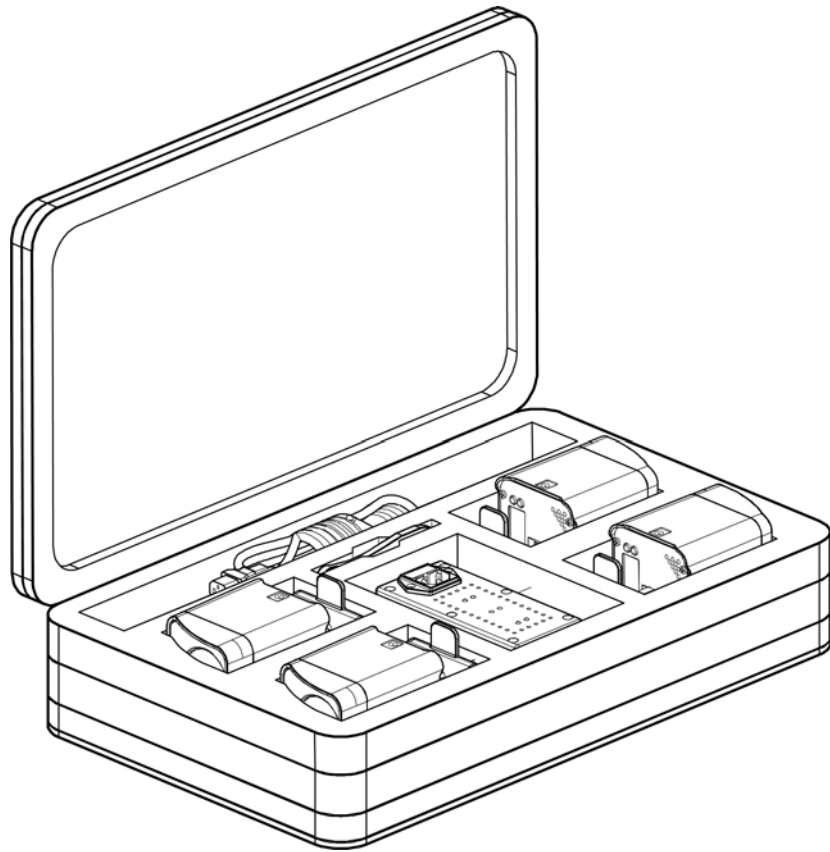

## TABLE OF CONTENTS

<b>1. Before You Begin</b> .....	1
What Is Included .....	1
Unpacking Instructions.....	1
Claims .....	1
Text Conventions .....	1
Symbols .....	1
Disclaimer .....	1
Product at a Glance .....	2
Safety Notes.....	2
<b>2. Introduction</b> .....	3
Product Overview.....	3
Product Dimensions.....	3
<b>3. Setup</b> .....	4
DC Power.....	4
AC Power (Multi-Charger).....	4
Fuse Replacement .....	4
Battery Power.....	5
Charging the Battery.....	5
Battery Life Indicator.....	5
Battery Run Time.....	5
Mounting .....	6
Orientation.....	6
Rigging .....	6
<b>4. Operation</b> .....	7
Control Panel Operation.....	7
Menu Map .....	7
Wireless DMX Linking .....	8
DMX Personality and Starting Address.....	8
Wireless DMX Configuration .....	8
DMX Channel Assignments and Values .....	9
12CH .....	9
8-CH.....	10
6-CH.....	10
Configuration (Standalone) .....	10
Automatic Programs.....	10
Auto-Program Speed .....	10
Sound-Active Mode.....	11
Sound-Sensitivity .....	11
Preset Color Mode .....	11
Custom Color Mixing.....	11
IRC-6 Infrared Remote Control .....	12
IRC-6 Operation .....	12
Master/Slave Mode .....	13
<b>5. Maintenance</b> .....	14
Product Maintenance .....	14
<b>6. Technical Specifications</b> .....	15
<b>Returns</b> .....	16
<b>Contact Us</b> .....	17

# 1. Before You Begin

## What Is Included

- 4x Freedom H1
- 4x Diffusers
- Multi-Charger
- IRC-6
- Carry Bag
- Warranty Card
- Quick Reference Guide

## Unpacking Instructions

Carefully unpack the product immediately and check the container to make sure all the parts are in the package and are in good condition.

## Claims





If the box or the contents (the product and included accessories) appear damaged from shipping, or show signs of mishandling, notify the carrier immediately, not Chauvet. Failure to report damage to the carrier immediately may invalidate your claim. In addition, keep the box and contents for inspection.

For other issues, such as missing components or parts, damage not related to shipping, or concealed damage, file a claim with Chauvet within 7 days of delivery.

## Text Conventions

Convention	Meaning
<b>1–512</b>	A range of values
<b>50/60</b>	A set of values of which only one can be chosen
<b>Settings</b>	A menu option not to be modified
<b>&lt;ENTER&gt;</b>	A key to be pressed on the product's control panel
<b>ON</b>	A value to be entered or selected

## Symbols

Symbol	Meaning
	Electrical warning. Not following these instructions may cause electrical damage to the product, accessories, or the user.
	Critical installation, configuration, or operation information. Not following these instructions may make the product not work, cause damage to the product, or cause harm to the operator.
	Important installation or configuration information. The product may not function correctly if this information is not used.
	Useful information.

## Disclaimer

Chauvet believes that the information contained in this manual is accurate in all respects. However, Chauvet assumes no responsibility and specifically disclaims any and all liability to any party for any loss, damage or disruption caused by any errors or omissions in this document, whether such errors or omissions result from negligence, accident or any other cause. Chauvet reserves the right to revise the content of this document without any obligation to notify any person or company of such revision, however, Chauvet has no obligation to make, and does not commit to make, any such revisions. Download the latest version from [www.chauvetdj.com](http://www.chauvetdj.com).









The works of authorship contained in this manual, including, but not limited to, all design, text and images are owned by Chauvet.

© Copyright 2018 Chauvet & Sons, LLC. All rights reserved.

Electronically published by Chauvet in the United States of America.

CHAUVET, the Chauvet logo, and Freedom H1 are registered trademarks or trademarks of Chauvet & Sons LLC (d/b/a Chauvet and Chauvet Lighting) in the United States and other countries. Other company and product names and logos referred to herein may be trademarks of their respective companies.

### Product at a Glance

Use on Dimmer		Auto Programs	
Outdoor Use		Auto-ranging Power Supply	
Sound-Active		Replaceable Fuse	
DMX		User-Serviceable	
Master/Slave			

### Safety Notes



- Always connect the product to a grounded circuit to avoid the risk of electrocution.
- Always disconnect the product from the power source before cleaning or replacing the fuse.
- Avoid direct eye exposure to the light source while the product is on.
- Make sure the power cord is not crimped or damaged.
- Never disconnect the product from power cord by pulling or tugging on the cord.
- If mounting the product overhead, always secure to a fastening device using a safety cable.
- Make sure there are no flammable materials close to the product when operating.
- Do not touch the product's housing when operating because it may be very hot.
- Do not charge the battery of the product in a closed case or container.



- Always make sure that the voltage of the outlet to which you are connecting the product is within the range stated on the decal or rear panel of the product.
- The product is for indoor use only! (IP20) To prevent risk of fire or shock, do not expose the product to rain or moisture.
- Always install the product in a location with adequate ventilation, at least 20 in (50 cm) from adjacent surfaces.
- Be sure that no ventilation slots on the product's housing are blocked.
- Never connect the product to a dimmer.
- Make sure to replace the fuse with another of the same type and rating.
- Never carry the product from the power cord or any moving part. Always use the hanging/ mounting bracket.
- The maximum ambient temperature (Ta) is 104 °F (40 °C). Do not operate the product at higher temperatures.
- In the event of a serious operating problem, stop using the product immediately.
- Never try to repair the product. Repairs carried out by unskilled people can lead to damage or malfunction. Please contact the nearest authorized technical assistance center.
- To eliminate unnecessary wear and improve its lifespan, during periods of non-use completely disconnect the product from power via breaker or by unplugging it.



Keep this User Manual for future use. If you sell the product to someone else, be sure that they also receive this document.

## 2. Introduction

### Product Overview

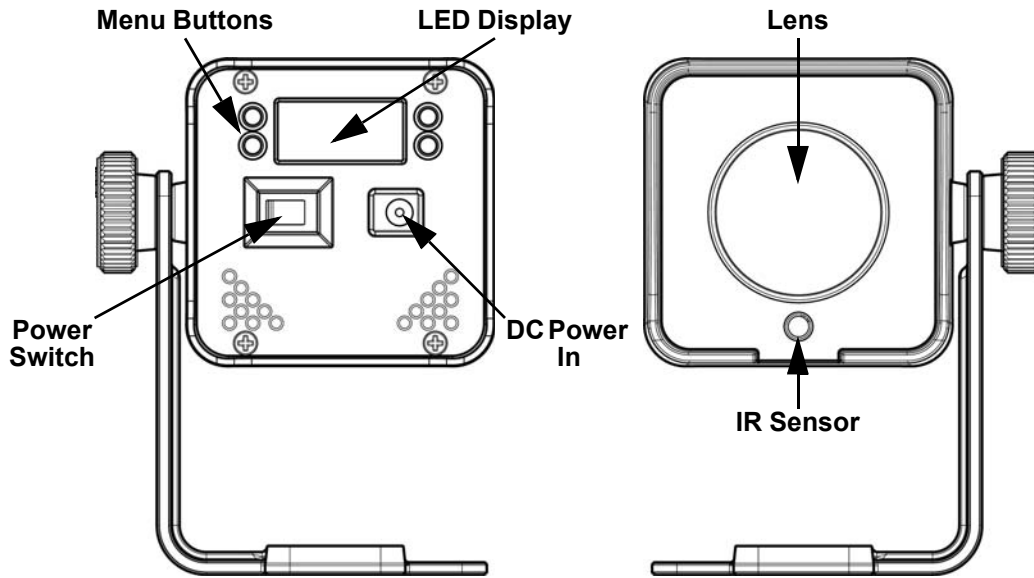

### Product Dimensions

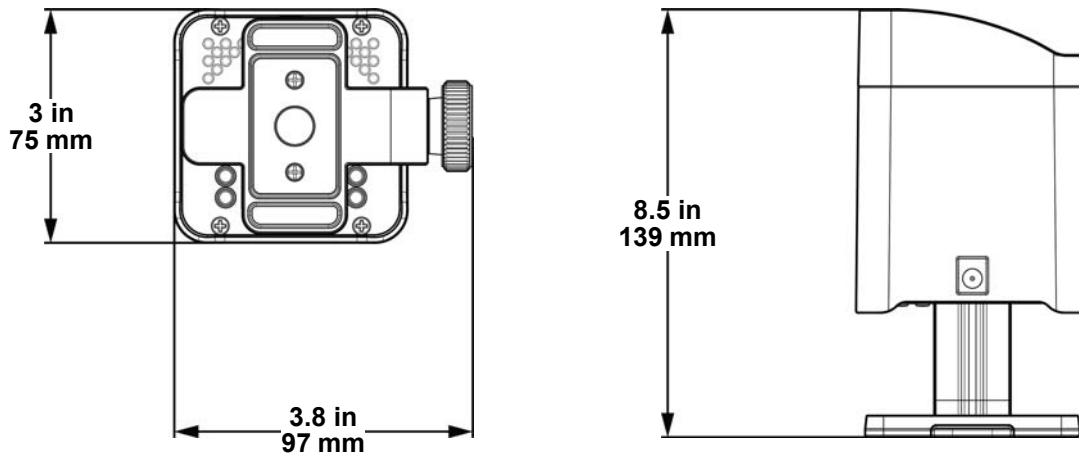

### 3. Setup

#### DC Power

The Freedom H1 comes with an external Multi-Charger that can charge the batteries of up to 4 Freedom H1 products at the same time.

#### AC Power (Multi-Charger)

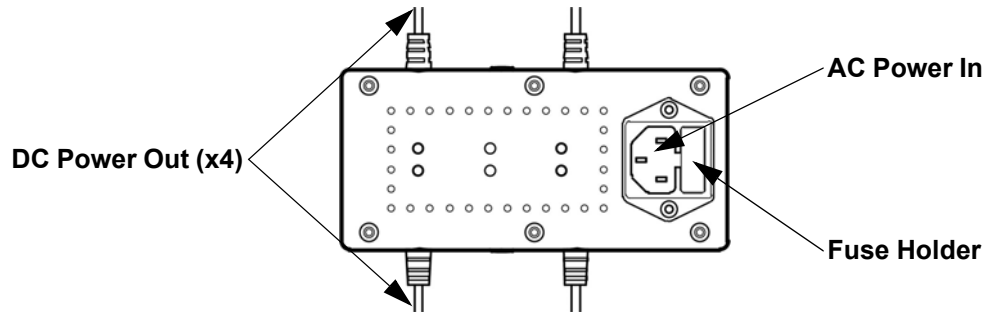

The Freedom H1 Multi-Charger is an auto-ranging power supply and it can work with an input voltage range of 100 to 240 VAC, 50/60 Hz. To determine the product's power requirements (circuit breaker, power outlet, and wiring), use the current value listed on the label affixed to the product's back panel, or refer to the product's specifications chart. The listed current rating indicates the product's average current draw under normal conditions.



- **Always connect the product to a protected circuit (a circuit breaker or fuse). Make sure the product has an appropriate electrical ground to avoid the risk of electrocution or fire.**
- **To eliminate unnecessary wear and improve its lifespan, during periods of non-use completely disconnect the product from power via breaker or by unplugging it.**



**Never connect the product to a rheostat (variable resistor) or dimmer circuit, even if the rheostat or dimmer channel serves only as a 0 to 100% switch.**

#### Fuse Replacement

1. Wedge the tip of a flat-head screwdriver into the slot of the fuse holder.
2. Pry the fuse holder out of the housing.
3. Remove the blown fuse from the holder and replace with a fuse of the exact same type and rating.
4. Insert the fuse holder back in place and reconnect power.

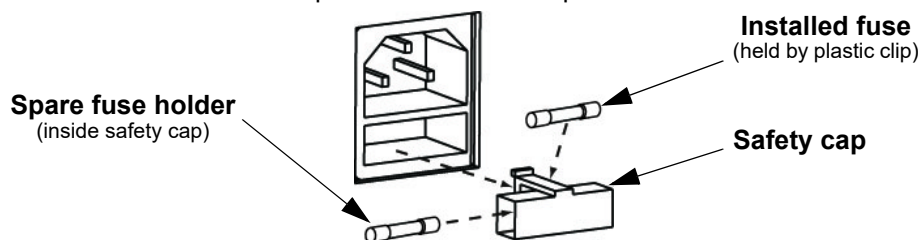

**Disconnect the Multi-Charger from the power outlet before replacing the fuse.**

## Setup

### Battery Power

The Freedom H1 comes with a rechargeable lithium battery for cable-free operation.

### Charging the Battery

The battery charges whenever the product is plugged into the Multi-Charger and the Multi-Charger is plugged into a power source. If the product is plugged in and not in operation, make sure the On/Off switch is in the **Off** position.



**Do not charge the battery of the product in a closed case or container.**

### Battery Life Indicator

The indicators on the LED Menu Display show how much battery life remains available. The drawing below provides a key to reading the battery life indicators.

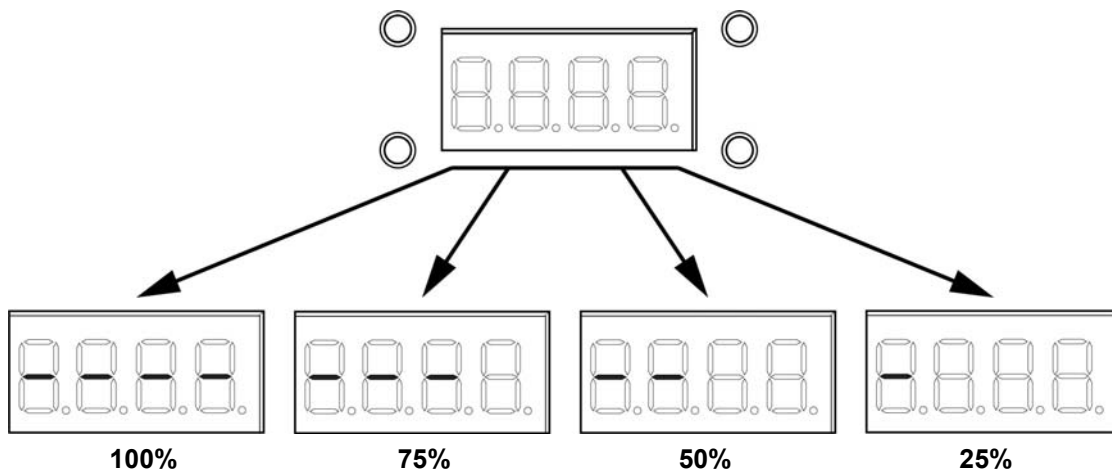

### Battery Run Time

<b>Maximum Run Time</b> (all colors on) Up to 8 hours	<b>Recharge Time</b> 7 hours
---	---------------------------------

### Mounting

Before mounting the product, read and follow the safety recommendations indicated in the [Safety Notes](#).

### Orientation

The Freedom H1 may be mounted in any position; however, make sure adequate ventilation is provided around the product.

### Rigging

- Before deciding on a location, always make sure there is easy access to the product for maintenance and programming purposes.
- Make sure adequate ventilation is provided around the product.
- Make sure that the structure or surface onto which you are mounting the product can support the product's weight. (see the [Technical Specifications](#))
- When mounting the product overhead, always use a safety cable. Mount the product securely to a rigging point, whether an elevated platform or a truss.
- When rigging the product onto a truss, use a mounting clamp of appropriate weight capacity.
- When power linking multiple products, mount the products close enough for power linking cables to reach.
- The bracket adjustment knob allows for directional adjustment when aiming the product to the desired angle. Only loosen or tighten the bracket knob manually. Using tools could damage the knob.

### Mounting Diagram

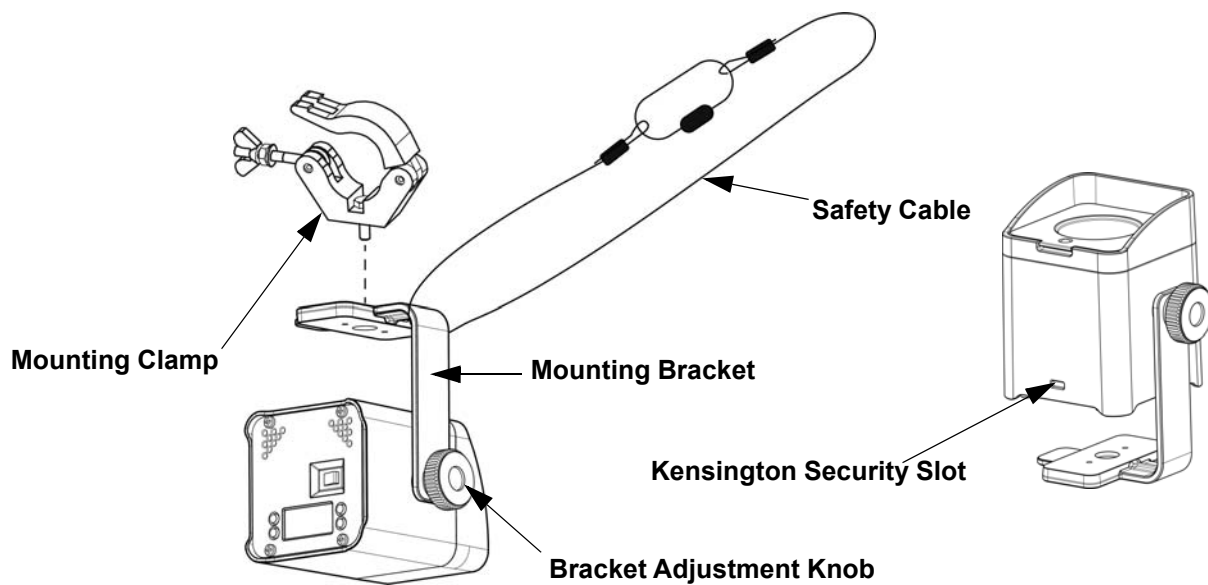



## 4. Operation

### Control Panel Operation

To access the control panel functions, use the four buttons located underneath the display. Please refer to the [Product Overview](#) to see the button locations on the control panel.

Button	Function
<MENU>	Press to find an operation mode or to back out of the current menu option
<UP>	Press to scroll up the list of options or to find a higher value
<DOWN>	Press to scroll down the list of options or to find a lower value
<ENTER>	Press to activate a menu option or a selected value

### Menu Map

Mode	Programming Levels		Description	
DMX Mode	6-CH	d 1–512	Sets DMX personality and starting address	
	8-CH			
	12CH			
Preset Colors	C--	C 1–63	Selects a preset static color	
Automatic Programs	P--	P 1–4	Automatic programs	
Auto Speed	S--	S 1–100	Program speed for P 1–4	
Sound-Active Mode	Snd	Snd	Sound-active programs	
Sound Sensitivity	SenS	u 1–100	Adjusts the sound sensitivity	
Custom Color Mixing	U--	r 0–255	Adjusts the red, green, blue, amber, white, and UV levels to create custom colors	
		g 0–255		
		b 0–255		
		A 0–255		
		W 0–255		
Dimmer Mode	dIM	OFF	Sets the dimmer curve: <b>dIM1</b> (fast) to <b>dIM3</b> (slow), or <b>oFF</b>	
		dIM1		
		dIM2		
		dIM3		
Infrared Mode	SEt	ON	Turns infrared on or off	
		OFF		
Wireless DMX	S-tr	drCH	dr 1–16	Turns on wireless DMX and sets transmitter or receiver channel
		dtCH	dt 1–16	

## Wireless DMX Linking

The Freedom H1 works with a DMX controller in Wireless DMX mode. In wireless DMX mode a lighting control board or D-Fi product must send wireless DMX signals to the products. Information about DMX is in the CHAUVET DMX Primer, which is available from the Chauvet website [http://www.chauvetlighting.com/downloads/DMX\\_Primer\\_rev05\\_WO.pdf](http://www.chauvetlighting.com/downloads/DMX_Primer_rev05_WO.pdf).

### DMX Personality and Starting Address

When selecting a starting DMX address, always consider the number of DMX channels the selected DMX mode uses. If you choose a starting address that is too high, you could restrict the access to some of the product's channels.

The Freedom H1 uses up to 12 DMX channels, which defines the highest configurable address as **501**.

If you are not familiar with the DMX protocol, download the DMX Primer from [www.chauvetdj.com](http://www.chauvetdj.com).

To select the starting address, do the following:

1. Press **<MENU>** repeatedly until **6-CH**, **8-CH**, or **12CH** shows on the display.
2. Press **<ENTER>**.
3. Use **<UP>** or **<DOWN>** to select the starting address, from **d 1–512**.
4. Press **<ENTER>**.

### Wireless DMX Configuration

The Freedom H1 offers wireless control of 2 or more products with a single DMX controller. To set up the D-Fi 2.4 GHz transceiver, follow the instructions below.

For the transmitting product:

1. Press **<MENU>** repeatedly until **S-tr** shows on the display.
2. Press **<ENTER>**.
3. Use **<UP>** or **<DOWN>** to select **dtCH**.
4. Press **<ENTER>**.
5. Use **<UP>** or **<DOWN>** to select the D-Fi channel, from **dt 1–16**.
6. Press **<ENTER>**.

For the receiving product(s):

1. Press **<MENU>** repeatedly until **S-tr** shows on the display.
2. Press **<ENTER>**.
3. Use **<UP>** or **<DOWN>** to select **drCH**.
4. Press **<ENTER>**.
5. Use **<UP>** or **<DOWN>** to select the D-Fi channel, from **dr 1–16**. The channel number should match the channel number of the transmitting product or controller.
6. Press **<ENTER>**.



**Caution: D-Fi 2.4 GHz operation can be interrupted or inhibited by obstructions between the transmitter and receiver such as structures or people. For best results, keep the line of sight clear.**



- **The Freedom H1 is fully compatible with the D-Fi 2.4 GHz wireless transceiver (transmitter/receiver) from Chauvet (sold separately). For more detailed information about D-Fi 2.4 GHz functionality, refer to the D-Fi 2.4 GHz User Manual available at the Chauvet website [www.chauvetdj.com](http://www.chauvetdj.com).**
- **Ensure that all linked products are configured to the same DMX personality.**

## DMX Channel Assignments and Values

### 12CH

Channel	Function	Value	Percent/Setting
1	Dimmer	000 ⇔ 255	0–100%
2	Red	000 ⇔ 255	0–100%
3	Green	000 ⇔ 255	0–100%
4	Blue	000 ⇔ 255	0–100%
5	Amber	000 ⇔ 255	0–100%
6	White	000 ⇔ 255	0–100%
7	Ultraviolet	000 ⇔ 255	0–100%
8	Strobe	000 ⇔ 010	No function
		011 ⇔ 255	Strobe, slow to fast
9	Color Macro	000 ⇔ 010	No function
		011 ⇔ 030	R: 100%    G: 0–100%    B: 0%    A: 0%
		031 ⇔ 050	R: 100–0%    G: 100%    B: 0%    A: 0%
		051 ⇔ 070	R: 0%    G: 100%    B: 0–100%    A: 0%
		071 ⇔ 090	R: 0%    G: 100–0%    B: 100%    A: 0%
		091 ⇔ 110	R: 0–100%    G: 0%    B: 100%    A: 0%
		111 ⇔ 130	R: 100%    G: 0%    B: 100–0%    A: 0%
		131 ⇔ 150	R: 100%    G: 0–100%    B: 0–100%    A: 0%
		151 ⇔ 170	R: 100–0%    G: 100–0%    B: 100%    A: 0%
		171 ⇔ 200	R: 100%    G: 100%    B: 100%    A: 100%
		201 ⇔ 205	Color 1
		206 ⇔ 210	Color 2
		211 ⇔ 215	Color 3
		216 ⇔ 220	Color 4
		221 ⇔ 225	Color 5
		226 ⇔ 230	Color 6
		231 ⇔ 235	Color 7
236 ⇔ 240	Color 8		
241 ⇔ 245	Color 9		
246 ⇔ 250	Color 10		
251 ⇔ 255	Color 11		
10	Auto/Sound-Active Programs	000 ⇔ 010	No function
		011 ⇔ 060	Auto program 1
		061 ⇔ 120	Auto program 2
		121 ⇔ 180	Auto program 3
		181 ⇔ 240	Auto program 4
241 ⇔ 255	Sound-active program		
11	Auto Speed (when CH 10 is 011 ⇔240)	000 ⇔ 255	Auto program speed, slow to fast
	Sound Sensitivity (when CH 10 is 241 ⇔255)	000 ⇔ 010	Sound-sensitivity off
		011 ⇔ 255	Sound sensitivity, low to high
12	Dimmer Speed Mode	000 ⇔ 051	Preset dimmer speed from display menu
		052 ⇔ 101	Dimmer speed mode off
		102 ⇔ 152	Dimmer speed mode 1 (fast)
		153 ⇔ 203	Dimmer speed mode 2 (medium)
		204 ⇔ 255	Dimmer speed mode 3 (slow)

## 8-CH

Channel	Function	Value	Percent/Setting
1	Dimmer	000 ⇔ 255	0–100%
2	Red	000 ⇔ 255	0–100%
3	Green	000 ⇔ 255	0–100%
4	Blue	000 ⇔ 255	0–100%
5	Amber	000 ⇔ 255	0–100%
6	White	000 ⇔ 255	0–100%
7	Ultraviolet	000 ⇔ 255	0–100%
8	Strobe	000 ⇔ 010	No function
		011 ⇔ 255	Strobe, slow to fast

## 6-CH

Channel	Function	Value	Percent/Setting
1	Red	000 ⇔ 255	0–100%
2	Green	000 ⇔ 255	0–100%
3	Blue	000 ⇔ 255	0–100%
4	Amber	000 ⇔ 255	0–100%
5	White	000 ⇔ 255	0–100%
6	Ultraviolet	000 ⇔ 255	0–100%

## Configuration (Standalone)

Set the product in one of the standalone modes to control without a DMX controller.



**Never connect a product that is operating in any standalone mode to a DMX string connected to a DMX controller. Products in standalone mode may transmit DMX signals that could interfere with the DMX signals from the controller.**

### Automatic Programs

To run the Freedom H1 in automatic mode, follow the instructions below:

1. Press **<MENU>** repeatedly until **P--** shows on the display.
2. Press **<ENTER>**.
3. Use **<UP>** or **<DOWN>** to select an automatic program, from **P 1–4**.
4. Press **<ENTER>**.

### Auto-Program Speed

To change the auto-program speed on the Freedom H1, do the following:

1. Press **<MENU>** repeatedly until **S--** shows on the display.
2. Use **<UP>** or **<DOWN>** to increase or decrease the program speed, from **S 1–100**.
3. Press **<ENTER>**. The product will return to the last selected mode.

## Operation

---

### Sound-Active Mode

To run the Freedom H1 in sound-active mode, follow the instructions below:

1. Press **<MENU>** repeatedly until **Snd** shows on the display.
2. Press **<ENTER>**.



**The product will only respond to low frequencies of music (bass and drums).**

### Sound-Sensitivity

To set the sound sensitivity on the Freedom H1, do the following:

1. Press **<MENU>** repeatedly until **SenS** shows on the display.
2. Use **<UP>** or **<DOWN>** to increase or decrease the program speed, from **u 1–100**.
3. Press **<ENTER>**. The product will return to the last selected mode.

### Preset Color Mode

To run the Freedom H1 on a static color, follow the instructions below:

1. Press **<MENU>** repeatedly until **C--** shows on the display.
2. Press **<ENTER>**.
3. Use **<UP>** or **<DOWN>** to select a static color, from **C 1–63**.
4. Press **<ENTER>**.

### Custom Color Mixing

To custom mix a static color, do the following:

1. Press **<MENU>** repeatedly until **U--** shows on the display.
2. Press **<ENTER>**. and one of the following will appear:
  - **r\_ \_ \_** (red)
  - **g\_ \_ \_** (green)
  - **b\_ \_ \_** (blue)
  - **A\_ \_ \_** (amber)
  - **W\_ \_ \_** (white)
  - **P\_ \_ \_** (UV)
3. Press **<ENTER>** to cycle through the color settings.
4. When the desired color shows on the display, use **<UP>** or **<DOWN>** to increase or decrease the color value, from **0–255**.
5. Repeat steps 3 and 4 until the product outputs as desired.

## IRC-6 Infrared Remote Control

The Freedom H1 is compatible with the IRC-6 infrared remote control from Chauvet. To activate IR mode, follow the instructions below:

1. Press **<MENU>** repeatedly until **SEt** shows on the display.
2. Press **<ENTER>** to accept.
3. Press **<UP>** or **<DOWN>** to select **ON** or **OFF**.
4. Press **<ENTER>**.

## IRC-6 Operation

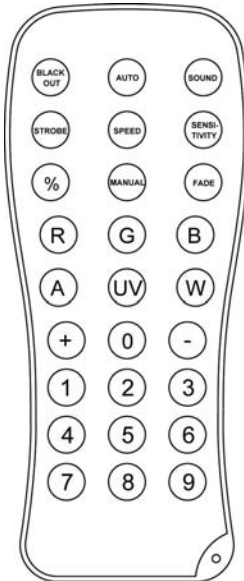

### Automatic Mode

Automatic mode will enable you to run the automatic programs on the product.

To turn on Automatic mode:

1. Press **<AUTO>** on the IRC-6.
2. Press **<+>** or **<->** to choose between the different auto programs.

To select only fading programs:

1. Press **<FADE>** on the IRC-6.
2. Press **<+>** or **<->** to choose between the different fading programs.

To adjust the speed of the automatic program:

1. Press **<SPEED>** on the IRC-6.
2. Press **<+>** or **<->** to increase or decrease the speed of the program.

### Sound-Active Mode

Sound-Active mode will enable the product to respond to the music.

To turn on Sound-Active mode:

1. Press **<SOUND>** on the IRC-6.
2. Press **<+>** or **<->** to select a sound-active program.

To adjust the sound sensitivity:

1. Press **<SENSITIVITY>** on the IRC-6.
2. Press **<+>** or **<->** to increase or decrease the sensitivity.

### Manual Color Control

To select a preset static color with the IRC-6:

1. Press **<1>**–**<9>** on the IRC-6.

To custom-mix a color with the IRC-6:

1. Press **<MANUAL>** on the IRC-6, or skip to step 2.
2. Select the color to be edited, from **<R>** (red), **<G>** (green), **<B>** (blue), **<A>** (amber), **<UV/P>** (UV), or **<W>**. (white).
3. Press **<+>** or **<->** to increase or decrease the value of the selected color.
4. Repeat steps 2 and 3 until the product outputs as desired.

### Strobe

To adjust the strobe rate:

1. Press **<STROBE>** on the IRC-6.
2. Press **<+>** or **<->** to increase or decrease the strobe rate.
3. Press **<STROBE>** again to turn off the strobe.

### Dimmer

To adjust the total output with the IRC-6:

1. Press **<%>** on the IRC-6.
2. Press **<+>** or **<->** to increase or decrease the output level.

### Black Out

To black out the lights:

1. Press **<BLACK OUT>** on the IRC-6.

This will turn off all the lights until the button is pressed again.

NOTE: The IRC-6 will not respond to any inputs when Black Out is activated. If the remote does not respond when a button is pressed, try pressing **<BLACK OUT>**. You may have inadvertently activated Black Out.

### Master/Slave Mode

The Master/Slave mode allows a single Freedom H1 product (the “master”) to control the actions of one or more Freedom H1 products (the “slaves”) without the need of a DMX controller or DMX cables. The master (transmitter) product will be set to operate in either Stand-Alone mode or with the IRC-6, while the slave (receiver) products will be set to operate in Slave mode. Once set and connected, the slave products will operate in unison with the master product.

Configure the products as indicated below.

#### Slave products:

1. Press **<MENU>** repeatedly until **S-tr** shows on the display.
2. Press **<ENTER>**.
3. Use **<UP>** or **<DOWN>** to select **drCH**.
4. Press **<ENTER>**.
5. Use **<UP>** or **<DOWN>** to select the receiving D-Fi channel, from **dr 1–16**.
6. Press **<ENTER>**.
7. Finish setting all the slave products.

#### Master product:

1. Press **<MENU>** repeatedly until **S-tr** shows on the display.
2. Press **<ENTER>**.
3. Use **<UP>** or **<DOWN>** to select **dtCH**.
4. Press **<ENTER>**.
5. Use **<UP>** or **<DOWN>** to select the transmitting D-Fi channel on which the slave products are receiving, from **dt 1–16**.
6. Press **<ENTER>**.
7. Set the master product to operate in Stand-Alone mode or with the IRC-6.



- **Configure all the slave products before connecting the master to the daisy chain.**
- **Never connect a DMX controller to a DMX string configured for Master/Slave operation because the controller may interfere with the signals from the master.**

## 5. Maintenance

### Product Maintenance

Dust build-up reduces light output performance and can cause overheating. This can lead to reduction of the light source's life and/or mechanical wear. To maintain optimum performance and minimize wear, clean your lighting products at least twice a month. However, be aware that usage and environmental conditions could be contributing factors to increase the cleaning frequency.

To clean the product, follow the instructions below:

1. Unplug the product from power.
2. Wait until the product is at room temperature.
3. Use a vacuum (or dry compressed air) and a soft brush to remove dust collected on the external surface/vents.
4. Clean all transparent surfaces with a mild soap solution, ammonia-free glass cleaner, or isopropyl alcohol.
5. Apply the solution directly to a soft, lint free cotton cloth or a lens cleaning tissue.
6. Softly drag any dirt or grime to the outside of the transparent surface.
7. Gently polish the transparent surfaces until they are free of haze and lint.



**Always dry the transparent surfaces carefully after cleaning them.**



## 6. Technical Specifications

### Dimensions and Weight

Length	Width	Height	Weight
3.8 in (97 mm)	3 in (75 mm)	5.5 in (139 mm)	1.4 lb (0.7 kg)

**Note:** Dimensions in inches rounded to the nearest decimal digit.

### Power

Power Supply Type	Range	Voltage Selection	Input Voltage
Switching (external)	100 to 240 VAC, 50/60 Hz	Auto-ranging	8.4 VDC, 1.35 A

Parameter	120 V, 60 Hz	230 V, 50 Hz
Consumption	35 W	35 W
Operating Current	0.05 A	0.03 A
Fuse	F 1 A, 250 V	F 1 A, 250 V

Power I/O	U.S./Worldwide	UK/Europe
Power input connector	IEC	IEC
Power Cord plug	Edison (U.S.)	Local Plug

### Light Source

Type	Color	Quantity	Power	Current	Lifespan
LED	Hex-color RGBAW+UV	1	10 W	3 A	50,000 hours

### Photometrics

Strobe Rate	Beam Angle	Field Angle	Illuminance @ 5 m (w/ filter)	Illuminance @ 5 m (w/o filter)
0 to 25 Hz	21°	32°	268 lux	314 lux

### Thermal

Maximum External Temperature	Cooling System
104 °F (40 °C)	Convection

### DMX

I/O Connector	Channel Range
Wireless	6, 8 or 12

### Ordering

Product Name	Item Code	UPC Number
Freedom H1	03031422	781462217709

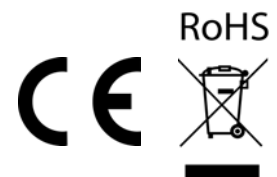

## Returns

In case you need to get support or return a product:

- If you are located in the U.S., contact Chauvet World Headquarters.
- If you are located in the UK or Ireland, contact Chauvet Europe Ltd.
- If you are located in Mexico, contact Chauvet Mexico.
- If you are located in Benelux, contact Chauvet Europe BVBA.
- If you are located in any other country, DO NOT contact Chauvet. Instead, contact your local distributor. See [www.chauvetdj.com](http://www.chauvetdj.com) for distributors outside the U.S., UK, Ireland, Mexico, or Benelux.



**If you are located outside the U.S., UK, Ireland, Mexico, or Benelux, contact your distributor of record and follow their instructions on how to return Chauvet products to them. Visit our website [www.chauvetdj.com](http://www.chauvetdj.com) for contact details.**

Call the corresponding Chauvet Technical Support office and request a Return Merchandise Authorization (RMA) number before shipping the product. Be prepared to provide the model number, serial number, and a brief description of the cause for the return.

To submit a service request online, go to [www.chauvetdj.com/service-request](http://www.chauvetdj.com/service-request).

Send the merchandise prepaid, in its original box, and with its original packing and accessories. Chauvet will not issue call tags.

Clearly label the package with the RMA number. Chauvet will refuse any product returned without an RMA number.



**Write the RMA number on a properly affixed label. DO NOT write the RMA number directly on the box.**

Before sending the product, clearly write the following information on a piece of paper and place it inside the box:

- Your name
- Your address
- Your phone number
- RMA number
- A brief description of the problem

Be sure to pack the product properly. Any shipping damage resulting from inadequate packaging will be your responsibility. FedEx packing or double-boxing are recommended.



**Chauvet reserves the right to use its own discretion to repair or replace returned product(s).**

## Contact Us

World Headquarters	
General Information	Technical Support
Address: 5200 NW 108th Ave. Sunrise, FL 33351 Voice: (954) 577-4455 Fax: (954) 929-5560 Toll Free: (800) 762-1084	Voice: (844) 393-7575 Fax: (954) 756-8015 Email: <a href="mailto:chauvetcs@chauvetlighting.com">chauvetcs@chauvetlighting.com</a>
	<b>Website</b> <a href="http://www.chauvetdj.com">www.chauvetdj.com</a>
EUROPE	
General Information	Technical Support
Address: Stokstraat 18 9770 Kruishoutem Belgium Voice: +32 9 388 93 97	Email: <a href="mailto:eutech@chauvetlighting.eu">eutech@chauvetlighting.eu</a>
	<b>Website</b> <a href="http://www.chauvetdj.eu">www.chauvetdj.eu</a>
General Information	Technical Support
Address: Unit 1C Brookhill Road Industrial Estate Pinxton, Nottingham, UK NG16 6NT Voice: +44 (0) 1773 511115 Fax: +44 (0) 1773 511110	Email: <a href="mailto:uktech@chauvetlighting.com">uktech@chauvetlighting.com</a>
	<b>Website</b> <a href="http://www.chauvetdj.eu">www.chauvetdj.eu</a>
MEXICO	
General Information	Technical Support
Address: Av. de las Partidas 34 - 3B (Entrance by Calle 2) Zona Industrial Lerma Lerma, México, C.P. 52000 Voice: +52 (728) 690-2010	Email: <a href="mailto:servicio@chauvet.com.mx">servicio@chauvet.com.mx</a>
	<b>Website</b> <a href="http://www.chauvetdj.mx">www.chauvetdj.mx</a>

Outside the U.S., United Kingdom, Ireland, Mexico or Benelux, contact the dealer of record. Follow the instructions to request support or to return a product. Visit our website for contact details.